

**RS-422/485 to 100Base-FX  
Device Server/Managed Media  
Converter**

**IRF-611  
User's Manual**

**(September 2006)**



## **COPYRIGHT**

All rights reserved. No part of this publication may be reproduced, stored in a retrieval system, or transmitted in any form or by any means, whether electronic, mechanical, photo copying, recording or otherwise, without the prior written permission of the publisher.

## **FCC WARNING**



This equipment has been tested and found to comply with the limits for a class A device, pursuant to part 15 of FCC rules. These limits are designed to provide reasonable protection against harmful interference in a commercial installation. This equipment generates, uses and can radiate radio frequency energy and, if not installed and used in accordance with the instructions, may cause harmful interference to radio communication. Operation of this equipment in a residential area is likely to cause harmful interference, in which case, the user will be required to correct the interference at the user's own expense.



This is a Class A product. In a domestic environment, this product may cause radio interference in which case the user may be required to take adequate measures.

Take special note to read and understand all the content in the warning boxes:



**Warning**

## TABLE OF CONTENTS

<b>1</b>	<b>ABOUT THIS GUIDE</b> .....	<b>1</b>
1.1	Welcome .....	1
1.2	Purpose .....	1
1.3	Terms/Usage .....	1
1.4	Features.....	1
1.5	Specifications .....	2
1.6	Package Contents.....	2
<b>2</b>	<b>HARDWARE DESCRIPTION</b> .....	<b>3</b>
2.1	Product Overview .....	3
2.2	Product Illustrations.....	3
<b>3</b>	<b>INSTALLATION</b> .....	<b>5</b>
3.1	Location.....	5
3.2	Din Rail Mounting Installation .....	6
3.3	Grounding IRF-611 .....	7
3.4	Redundant Power Inputs.....	7
3.5	External Alarm Contacts .....	8
3.6	Connecting Fiber Cable.....	9
3.7	Terminal Block Connector (RS-422/485).....	9
<b>4</b>	<b>LED INDICATORS</b> .....	<b>10</b>
<b>5</b>	<b>USER INTERFACE STARTUP</b> .....	<b>11</b>
5.1	Web GUI.....	11
<b>6</b>	<b>CONFIGURATION MANAGEMENT</b> .....	<b>12</b>
6.1	System Details .....	12
6.1.1	System Information .....	12
6.1.2	Master Information .....	12
6.2	Interface Configurations .....	13
6.2.1	Serial Port Configuration .....	13
6.2.2	Serial Connect Status.....	15
6.3	Management Configurations .....	15
6.3.1	User Configuration .....	15
6.3.2	Firmware Download .....	16
6.3.3	SNMP Configuration.....	16
6.4	System Restart.....	18
<b>7</b>	<b>APPENDIX: SERIAL IP REDIRECTOR</b> .....	<b>19</b>

**8 CONTACT INFORMATION .....23**

## 1 About This Guide

### 1.1 Welcome

Thank you for selecting the RS-422/485 to 100Base-FX Device Server / Managed Media Converter. This unit is designed to provide a RS-422/485 connection over fiber cable where the connected devices have RS-422/485 interfaces. Enabling serial devices such as CNCs and PLCs to instantly connect to an existing Ethernet/ Fast Ethernet network, the Serial-to-Ethernet Device Server / Managed Media Converter represents a robust solution for devices controllers for MIS personnel.

### 1.2 Purpose

This guide discusses how to install and configure your RS-422/485 to 100Base-FX Device Server / Managed Media Converter.

### 1.3 Terms/Usage

In this guide, the term “Device Server / Managed Media Converter” (first letter upper case) refers to your RS-422/485 to 100Base-FX Device Server / Managed Media Converter, and “device server / managed media converter” (first letter lower case) refers to other device servers / managed media converters.

### 1.4 Features

- Device Server & Managed Media Converter Mode option
- Complies with EIA/TIA-422 & 485 standards
- 100Mbps Fast Ethernet fiber port
- Supports serial port asynchronous data rates up to 115.2 Kbps
- Relay output for power failure and link down
- Available with ST/SC connector for Multi-mode or SC connector for Single Mode
- Extends distance of up to 2km (6600 feet) multi-mode fiber and 120km (396000 feet) long-haul single mode fiber
- Terminal Block for RS-422/485 wiring
- DIP switch for 4-wire full and 2-wire asynchronous transmission
- Extends distances up to 1.2km for 24AWG Shielded Twisted Pair Cable
- DIP switches to enable/disable alarm function
- LEDs for ‘at-a-glance’ device status
- Suitable for industrial harsh environment
- Wide voltage range (9 ~ 48V DC)
- Redundant dual DC power inputs with Terminal Block
- FCC Class A & CE approved

## **1.5 Specifications**

**Standards:** IEEE 802.3u (100BASE-FX/ Fast Ethernet);  
EIA/TIA RS-422/485; EIA/TIA-574

**Ports:** 1x Fiber; Single Mode / Multi-Mode  
1x 5-pin terminal block serial connector

**Max. Distance:** Fiber: Up to 120,000 meters  
Serial: 1,200 meters (RS-422/485)

**Data Rates:** Fiber: 100 Mbps  
Serial: 115.2 kbps (asynchronous)

**Signals:** RS-422: TxD+/-, RxD+/-, GND  
RS-485: Data+, Data-, GND

**Switches:** DIP 1: Enables / disables primary power alarm  
DIP 2: Enables / disables redundant power alarm  
DIP 3: Enables / disables fiber port alarm  
DIP 4: N/A  
DIP 5: N/A  
DIP 6: N/A  
DIP 7: 2W 485 (ON) and 4W 422/485 (OFF) operations mode  
DIP 8: Enables / disables termination (TMR)

**Power:** External power adapter; 9~48V DC @ 1A

**Environment:** Temperature: Operating: 0°C to 70°C  
Relative Humidity: 10% to 80%, non-condensing  
Storage: -20°C to 80°C  
Relative Humidity: 5% to 90%, non-condensing

**Emissions:** FCC Part 15 of Class A & CE approved

**Dimensions:** 100 x 50 x 120mm (D x W x H)

**Weight:** 450 grams

## **1.6 Package Contents**

The package should include the following:

- One IRF-611 Device Server / Managed Media
- Converter unit
- DIN Rail Kit
- Protective port caps
- Quick Installation Guide
- User's Manual CD
- Serial IP Redirector software CD

## 2 Hardware Description

### 2.1 Product Overview

The Device Server features complete Ethernet and TCP/IP network support that allows devices in industry with RS-422/485 connectors such as milling machines, measurement instruments, and robots to connect to LAN based automation. Other devices typically found on campus networks such as card readers, code readers, lab equipment, medical equipment, and other similar serial devices can now instantly migrate to a TCP/IP network. Additionally, by deploying the device server, enable users to monitor and manage up to 256 serial devices from single PC with the help of Serial IP Redirector software for Device Server mode.

### 2.2 Product Illustrations

#### Front View

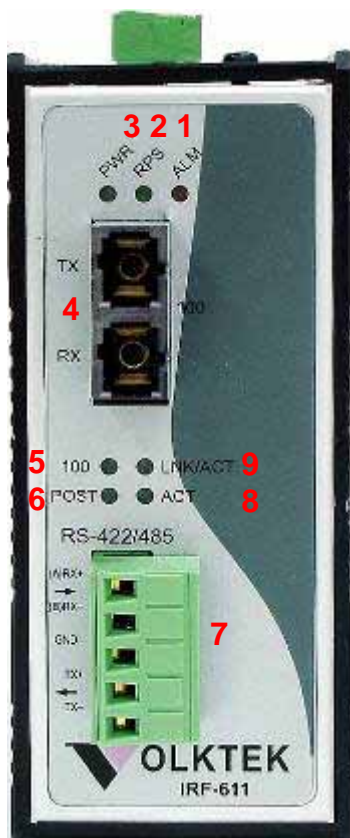

1. Alarm LED
2. Redundant Power LED
3. Primary Power LED
4. Fiber port
5. Fiber port 100Mbps LED
6. Power on Self Test LED
7. RS-422/485 serial port
8. Fiber port LNK/ACT LED
9. Serial port ACT LED

TOP View

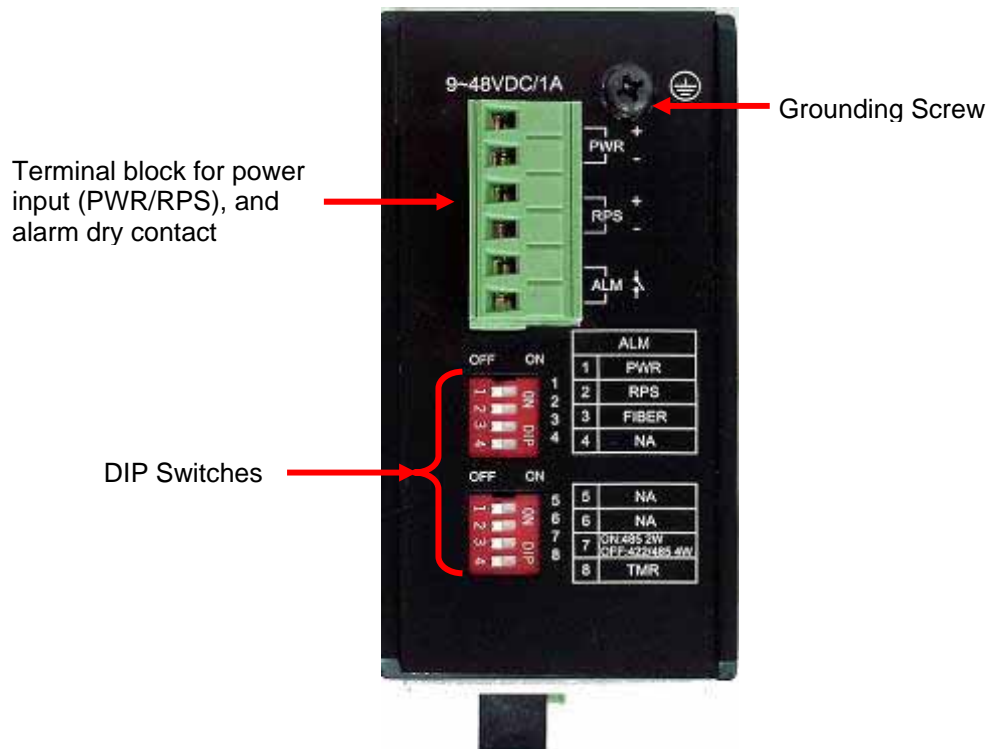

Back View

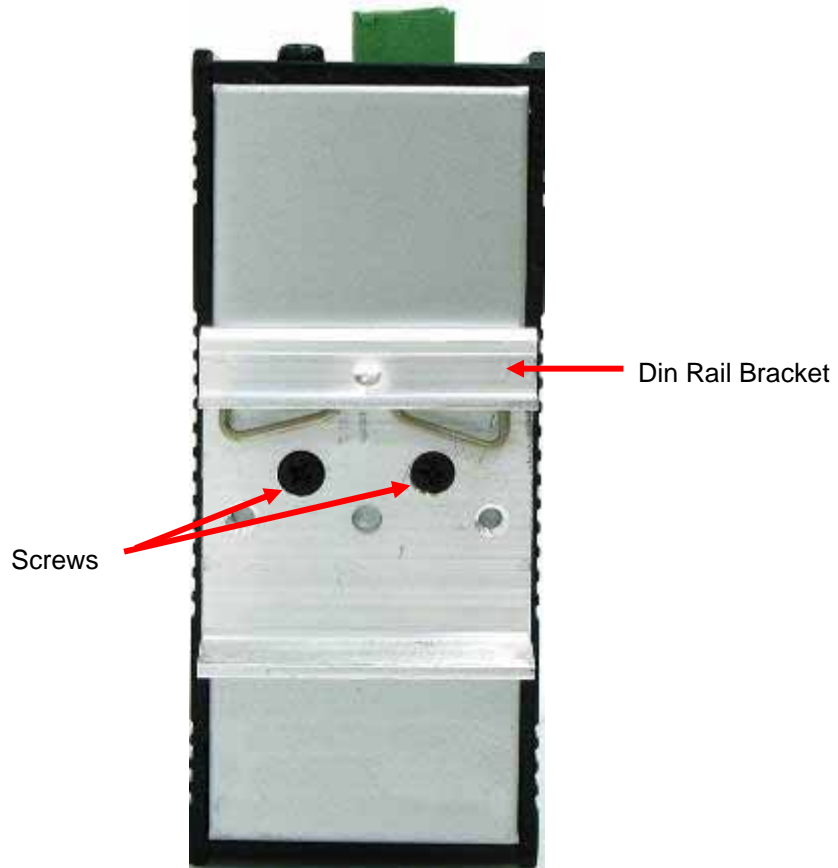



## **3 Installation**

To install your Device Server / Managed Media Converter, please see the following procedures:

- Location
- Din Rail Mounting
- Grounding Power
- Redundant Power Inputs
- External Alarm Contacts
- Connecting Fiber Cables
- Terminal Block Connector (RS-422/485)

### **3.1 Location**

The location selected for installing the Device Server / Managed Media Converter may greatly affect its performance. When selecting a site, we recommend considering the following rules:

1. Install the Device Server / Managed Media Converter in a fairly cool and dry place. See *Technical Specifications* for the acceptable temperature and humidity operating ranges.
2. Install the Device Server / Managed Media Converter in a location free from strong electromagnetic field generators (such as motors), vibration, dust, and direct exposure to sunlight.
3. Leave at least 5cm of space at the front and rear of the unit for ventilation.
4. Affix the provided rubber pads to the bottom of the Device Server for grip, and to protect the case from scratching.

### 3.2 Din Rail Mounting Installation

The aluminum DIN Rail attachment plate should already be affixed to the back panel of the Device Server / Managed Media Converter. If you need to attach the DIN Rail plate, assure that the stiff metal spring is situated towards the top. Attaching the Device Server / Managed Media Converter to the DIN rail is easy, just align, and attach the top rail, then press down and snap forward the Device Server / Managed Media Converter to snap in the bottom rail, as shown in the figures below.

Use following steps set up the Device Server / Managed Media Converter:

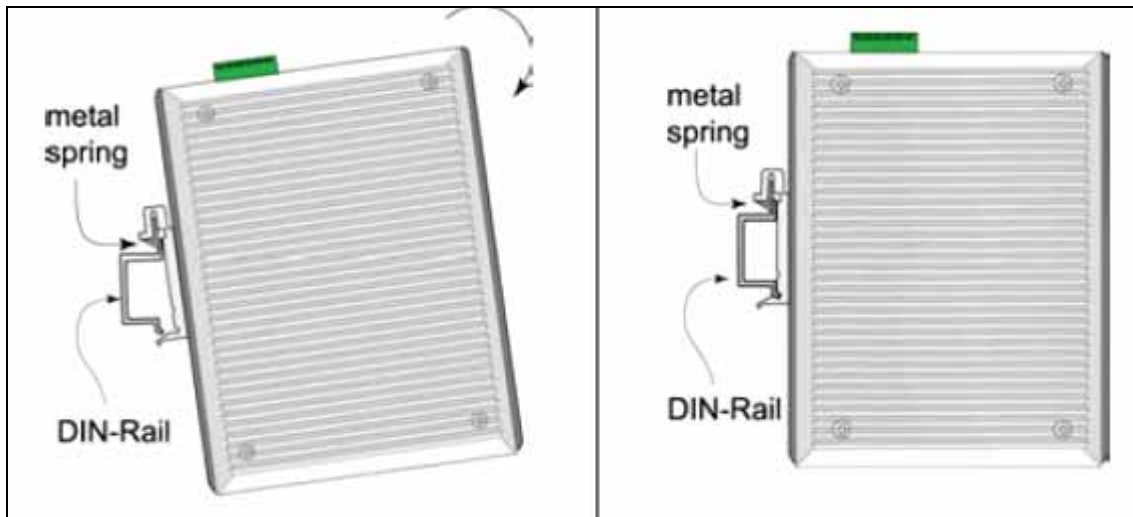

- The surface must support at least 1,000 gm for the Device Server / Managed Media Converter.
- The power outlet should be within 1.82 meters (6 feet) of the Device Server / Managed Media Converter.
- Visually inspect the power adapter and make sure that it is properly connected.

Make sure that there is proper heat dissipation from and adequate ventilation around the Device Server / Managed Media Converter. Do not place heavy objects on the unit.



**Warning Please exercise caution when using power tools. Also, install this unit away from damp or wet locations, or in close proximity to very hot surfaces. These types of environments can have a detrimental effect on the unit and cables.**

### 3.3 Grounding IRF-611



Be sure to disconnect the power cord before installing and/or wiring your IRF-601. Calculate the maximum possible current in each power wire and common wire. Observe all electrical codes dictating the maximum current allowable for each wire size. If the current goes above the maximum ratings, the wiring could overheat and causing serious damage to your equipment.

Users must pay attention to the following items.

- Use separate paths to route wiring for power and devices. If power wiring and device wiring paths must cross, make sure the wires are perpendicular at the intersection point.
- Do not run signal or communications wiring and power wiring in the same wire conduit. To avoid interference, wires with different signal characteristics should be routed separately.
- User can use the type of signal transmitted through a wire to determine which wires should be kept separate. The rule of thumb is that wiring that shares similar electrical characteristics can be bundled together.
- Keep input and output wiring separated.
- It is strongly recommended that you label wiring to all devices in the system for clarity.

**Grounding** IRF-611 will help eliminate the effects of noise due to electromagnetic interference (EMI). Always run the ground connection from the ground screw to the grounding surface prior to connecting DC power.



This product is intended to be mounted to a well-grounded mounting surface.

### 3.4 Redundant Power Inputs

Dual power inputs can be connected simultaneously to live DC power sources. If one power source fails, the other live source acts as a backup, and automatically supplies the unit's power needs.

Configure DC power to the Terminal Block Receptor as below.



**DC Powered unit:** Power is supplied through an external DC power source. Check the technical specification section for information about the DC power input voltage.

Since the unit does not include a power switch, plugging its power adapter into a power outlet will immediately power it on.

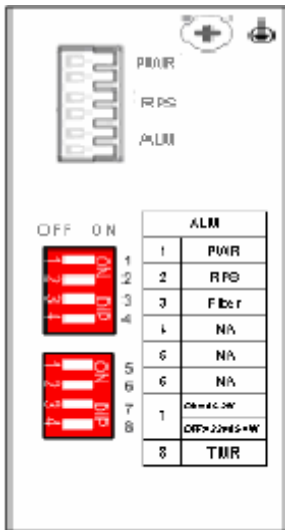

The plastic green colored contact power block (shown in the diagram to the left) is composed of six contacts and can be inserted and removed easily by hand to connect to the six pin terminal block receptor (male contacts located on the body of the Device Server / Managed Media Converter). The top two contacts (PWR) are designated for the primary DC input, while the middle two contacts (RPS) are redundant DC input. The lower two contacts (ALM) are for connection to an external alarm.

To the upper right of the power block is the ground wire connection screw, and below the power block is the DIP switch control panel. Procedure for Configuring DC Power:

During shipping, the removable green Contact Block may already be detached from the six pin terminal contact point. It may be easier to attach the DC wires to the green Contact

Block if it has first been unplugged from the terminal contact point on the Device Server / Managed Media Converter.

- A. On the Power Contact Block, use a flathead screwdriver to loosen the screws reserved for primary power (labeled PWR +/-) and then insert negative and positive DC wires. Tighten until snug.
- B. For the backup DC connection, follow the same procedure as above. Attach DC power wires to the Contact Block (in the position marked RPS +/-)
- C. If not already inserted into the terminal block receptor into the Device Server / Managed Media Converter, do so now.
- D. Assure your DC power supply is stable and clean before applying DC power to the Device Server / Managed Media Converter.

### 3.5 External Alarm Contacts

The IRF-611 has one Alarm Contact located on the green Power Block Contact on the top panel. For detailed instructions on how to connect the Alarm Contact power wires to the two lower contacts of the 6-contact terminal block connector, see the Connecting DC Power inputs in the section above (it is the same procedure).

You can connect the Fault circuit to any warning light which the user's factory or industry already has located in the control room or factory floor. When a fault occurs, the Device Server / Managed Media Converter will send a signal through the Alarm contact, to activate the external alarm or siren. The Alarm Contact has two terminals that form a Fault circuit for connecting to an alarm system.

An alarm will be signaled in the following situations:

1. Any link fail (ex: cable disconnected, device break down .....
2. PWR/RPS: Power failure
  - a. Power cord is disconnected, power supply malfunction, etc.
  - b. Input power is out of the range listed in the spec (9~ 48V)

### 3.6 Connecting Fiber Cable

When connecting fiber cable to a 100BASE-FX port on the Device Server, be sure the correct type – ST, SC, or WDM - connector is used. Follow the steps below to properly connect fiber cable:

1. Remove and keep the ST/SC/WDM port's rubber cover. When not connected to a fiber cable, the rubber cover should be replaced to protect the optics.
2. Check that the fiber terminators are clean. You can clean the cable plugs by wiping them gently with a clean tissue or cotton ball moistened with a little ethanol. Dirty fiber terminators on fiber optic cables will impair the quality of the light transmitted through the cable and lead to degraded performance on the port.
3. Connect one end of the cable to the ST/SC/WDM port on the Device Server and the other end to the ST/SC/WDM port on the other device.

**Note:** *When inserting the cable, be sure the tab on the plug clicks into position to ensure that it is properly seated.*

4. Check the corresponding port LED on the Device Server / Managed Media Converter to be sure that the connection is valid. (Refer to the LED chart in next section)



**Warning** Because invisible laser radiation may be emitted from the aperture of the fiber port when no cable is connected, avoid exposure to laser radiation and do not stare into the open apertures.

### 3.7 Terminal Block Connector (RS-422/485)

The 5-pin terminal block connector is provided at the front panel of the unit. During shipping, the removable green terminal block may already be detached from the five pin terminal contact point. It may be easier to attach the serial cable wires to the green terminal block if it has first been unplugged from the terminal contact point on the unit.

On the terminal block, use a flathead screwdriver to loosen the screws and then insert the related cable as shown in the figure below. Tighten screws until snug.

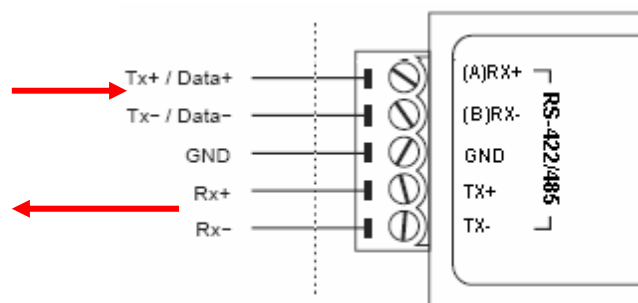

RS-422/485 cabling

## 4 LED Indicators

This Device has LED indicators located at the front of the device. The LEDs have been designed to give easy at-a-glance network status, and provides 'real-time' connectivity information. Please see below for an interpretation of their functions:

**Power Indicator (PWR):** This LED lights green when the Device Server / Managed Media Converter is receiving power from primary input.

**Redundant Power Supply (RPS):** This indicator lights green when the Device Server / Managed Media Converter is receiving power from redundant input.

### **Alarm (ALM)**

This indicator will light red and will signal an alarm (when an external alarm is connected) during a down link condition on any port and/or during primary/redundant power failure to the Device Server / Managed Media Converter.

### **100 LED**

Illuminated (amber) to indicate when receiving data from at 100Mbps (fiber port only).

### **LNK/ACT LED**

Flashing (amber) to indicate when receiving link pulses from a compliant device (fiber port only).

### **POST LED**

Illuminated (amber) when successfully performed Power on Self Test. Flashing while performing the POST.

### **ACT LED**

LED indicates ACT status of serial port; illuminates to indicate receiving link pulses from a compliant device.

## 5 User Interface Startup

You can use web browser for configuring this Device Server / Managed Media Converter for use. Set the device IP and TCP configuration to monitor/managed the attached serial device via Serial IP Redirector software for Device Server mode.

### 5.1 Web GUI

The Device Server / Managed Media Converter is accessible via a web browser once connected to the network. Type the IP address at web browser **192.168.0.254** (if connecting with default IP). A window will be prompted for entering user name and password.



(Note: We use IP 192.168.0.200 to write this manual)

After successful login, the main screen will appear as the following:

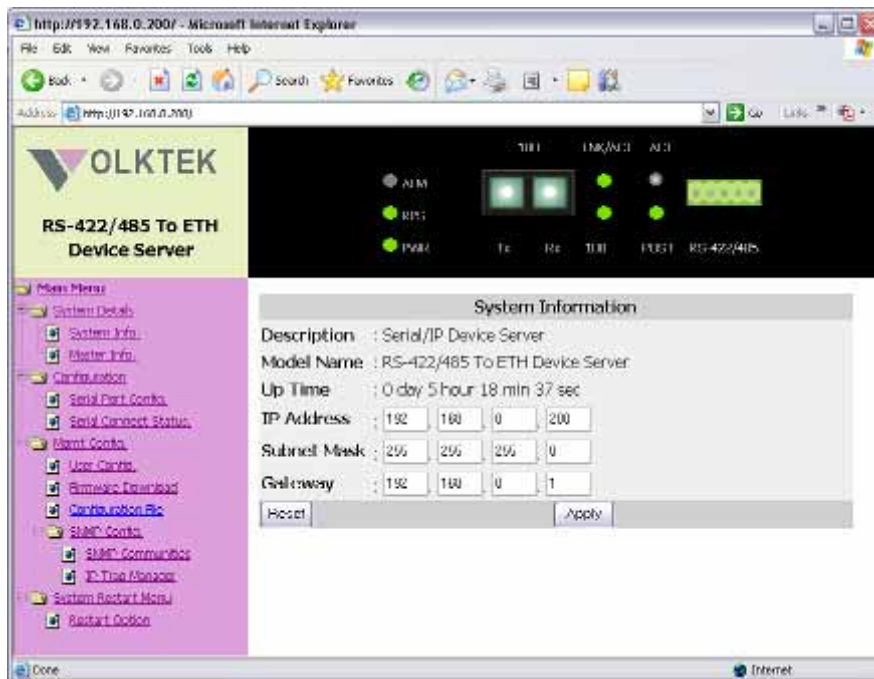

Note: The Device Server / Managed Media Converter (IRF-611) only offers web based management for its own management.

## 6 Configuration Management

Please see previous chapter to log-in the Device Server / Managed Media Converter Web. Once you logged in the following main screen will appear.

### 6.1 System Details

This category has two options:

- a) System information
- b) Master Info

#### 6.1.1 System Information

System information is as shown below. It shows IP Address, Subnet Mask and Gateway settings. After editing the setting press **Apply** to implement the settings.

System Information				
Description	: Serial/IP Device Server			
Model Name	: RS-422/485 To ETH Device Server			
Up Time	: 0 day 5 hour 55 min 51 sec			
IP Address	: 192	: 168	: 0	: 200
Subnet Mask	: 255	: 255	: 255	: 0
Gateway	: 192	: 168	: 0	: 1
<input type="button" value="Reset"/>		<input type="button" value="Apply"/>		

#### 6.1.2 Master Information

Master Info shows the hardware and firmware version.

Master Information	
Hardware Version	: 6700-00611-0101
Firmware Version	: 1.00.00 (built at May 25 2005 15:56:10)



## 6.2 Interface Configurations

This page offers the selection between Device Server and Media Converter mode. Please select the appropriate required for your application. User can also monitor the serial port status and configure TCP port number from this menu.

### 6.2.1 Serial Port Configuration

**RS422/485 Transfer Configuration** window will show you the serial port configuration and allow assigning the TCP port number to operate via Serial IP Redirector software for Device Server mode. The unit also offers two modes (Device Server Mode / Media Converter). Please restart the unit after selecting the mode to take effect.

RS422/485 Transfer Configuration	
<b>Server/Client Mode Configuration</b>	
Server/Client Type	: Auto
Remote IP	: <input type="text" value="192.168.0.1"/>
TCP Port Number	: <input type="text" value="1234"/> (value=1024~65535)
Connection Idle Time (sec)	: <input type="text" value="60"/> s (value=30~3600)
DS/CR Mode	: <input type="text" value="Device Server"/>
Packet mode of serial input	: <input type="text" value="Disable"/>
Packet mode inter-packet timeout	: <input type="text" value="20"/> mS (value=1~5000)
<b>Serial Port Configuration</b>	
Operation Mode	: CONSOLE MODE
Baud Rate	: <input type="text" value="38400"/>
Parity	: <input type="text" value="None"/>
Word Length	: <input type="text" value="8"/>
Stop Bits	: <input type="text" value="1"/>
Flow Control	: <input type="text" value="None"/>

EXPLANATION: Server/Client Mode Configuration	
Server/Client Type	A read-only attribute. In Device Server mode, the device will have a Server role as a TCP Server. In Media Converter mode, the "Server" and "Client" roles of the two ends will be decided automatically.
Remote IP	In Media Converter mode, set the IP address of the other end device. Ignore if in Device Server mode.
TCP Port Number	The TCP port number that the TCP Server is "bound" to.
Connection Idle Time	In seconds. This is valid for Media Converter mode only. The Client will disconnect the TCP session if no packets are transmitted in the set period.
DS/CR Mode	DS: Device Server mode – the Device Server acts as TCP Server and the Serial IP Redirector software acts as TCP Client. CR: Media Converter mode – two Device Servers communicate with each other through point-to-point architecture.
Packet mode of serial input	This is valid for Device Server mode only. Enabled – input data from the serial interface is treated as serial packets. Disabled – input data from the serial interface is treated as bit streams.
Packet mode inter-packet timeout	In milliseconds. This is valid for Device Server mode only. It is the delimiter value for recognizing the timeout gap between serial packets if Packet Mode is enabled.
Serial Port Configuration	
Operation Mode	A read-only attribute. It shows the RS232/422/485 mode set by the DIP switch.
Baud Rate	The speed of the serial interface.
Parity	Select or disable the parity checking method
Word Length	The length of data in bits
Stop Bits	The bit length of stop bits
Flow Control	The flow control method for informing the correspondent

Serial port configuration of Baud Rate, Parity and etc. will be auto-managed by Serial IP Redirector software and will be displayed. There is no option to manually select/change these values.

In case you are using a serial device with Modbus RTU protocol, do not forget to "Enable" Packet mode of serial input. Also put appropriate inter-packet timeout value to allow the smooth data communication.

**Note:** You will not be able to change the serial port settings (Baud Rate, Parity, Stop bits etc) while working in Device Server mode; they are managed through IP Serial Redirector software.

### 6.2.2 Serial Connect Status

**Serial Connect Status** will show the serial port connection to the serial device. Serial port settings can only be changed when using Media Converter mode.

RS422/485 Connection Status	
Connect Status	: Server-Type
Peer IP Address	: 192.168.0.21
Dest/Srce Port Number	: 4081 / 1234
Byte Counts From UART	: 12038
Byte Counts To Network	: 12038
Byte Counts From Network	: 123
Byte Counts To UART	: 123

User can get the instant information about the connectivity.

**Connect Status:** Server or Client

**Peer IP Address:** IP of remote PC access the serial device via Device Server

**Dest/Srce Port Number:** Showing the destination and source Port numbers. Source port number will be as configured.

**Byte Counts From UART:** Displaying the number of bytes transmitted from serial device.

**Byte Counts to Network:** Displaying the number of bytes received to TCP/IP network.

**Byte Counts From Network:** Displaying the number of bytes transmitted from Network.

**Byte Counts to UART:** Displaying the number of bytes received to serial device.

### 6.3 Management Configurations

This category offers multiple management options as the following sections.

#### 6.3.1 User Configuration

This option will allow user to change the “username” and “user password” for the device server management.

User Configuration	
User Name	User Password
<input type="text" value="admin"/>	<input type="text"/>
<input type="button" value="Reset"/>	<input type="button" value="Apply"/>

Type the new user name in the “User Name” and password to “User Password”. Selecting **Apply** will implement the new user name and password, which will be required to manage the device server.



**It is recommended to keep a written record in a safe place for the User Name and Password. In case, you lost the both or either one, you need to reset the system to default setting. This can be done by pressing a button at S1 location of PCB (near to capacitor) after removing the casing.**

### 6.3.2 Firmware Download

The user can download the newer/latest firmware to upgrade the device server / managed media converter once available. The user has two options, either they can upgrade via HTTP with browse option to select the firmware file.

The screenshot shows two sections for firmware upgrade. The first section, 'Upgrade System by HTTP', contains a 'File Name' input field with a 'Browse...' button and a 'Start Upgrade by HTTP' button. The second section, 'Upgrade System by TFTP', contains an 'IP Address' field with four sub-inputs for octets, a 'File Name' input field, and a 'Start Upgrade by TFTP' button.

If using TFTP method, user must provide the valid IP address of TFTP server and the file name, i.e. VK413.bin.

Once enter the parameters press “Start Upgrade by HTTP / TFTP” to upgrade the firmware. The window will appear to show the time to before restarting the device server to implement the upgraded firmware.

### 6.3.3 SNMP Configuration

You can use an external SNMP-based application to configure and manage the Device Server / Managed Media Converter. This management method requires the SNMP agent on the Device Server / Managed Media Converter and the SNMP Network Management Station to use the same community string. This management method, in fact, uses two community strings: the **Get** community string and the **Set** community string. If the SNMP Network Management Station only knows the **Set** community string, it can read and write to the MIBs. However, if it only knows the **Get** community string, it can only read MIBs. The default **Get** and **Set** community strings for the Device Server are public and private respectively.

#### SNMP Communities

The screenshot shows a table titled 'SNMP Communities'. The table has two columns: the first column lists the community type (GET and SET), and the second column lists the 'Community Name' with corresponding input fields. Below the table are 'Reset' and 'Save' buttons.

SNMP Communities	
	Community Name
GET	public
SET	private

If needed, assign the new parameters and press **Save** to implement the settings.

**IP Trap**

The following figure and table describe how to specify management stations that will receive authentication failure messages or other trap messages from the Device Server / Managed Media Converter. Up to 5 trap managers can be assigned.

IP Trap Manager		
IP Address	Community Name	Status
<input type="text" value="192.168.0.59"/>	<input type="text" value="public"/>	Enabled ▾
<input type="text" value="192.168.1.112"/>	<input type="text" value="private"/>	Disable ▾
<input type="text" value="0.0.0.0"/>	<input type="text" value="public"/>	Disable ▾
<input type="text" value="0.0.0.0"/>	<input type="text" value="public"/>	Disable ▾
<input type="text" value="0.0.0.0"/>	<input type="text" value="public"/>	Disable ▾

Click on each parameter field to modify the desired setting, then click on **Undo** to restore previously saved configurations or click on **Save** to retain newly entered information. See descriptions below:

Parameter	Description
IP Address	Enter the IP address of terminals for when abnormalities on a connection occur and an alarm to be sent. Enter their community names and disable or enable their alarm function accordingly
Community Name	Enter their community names
Status	Disable or enable their alarm function

## 6.4 System Restart

Users can restart/reset the system via software from a remote location.

### Restart Options

System Restore Factory Default Settings

Restore the factory default settings of the Device.

System Reset

Press "Reset" if the device is abnormally functioning.



Clicking on the Restore button will set the device server / managed media converter back to factory defaults. All saved configurations will be lost.

## 7 Appendix: Serial IP Redirector

Install the Serial IP Redirector software from CD-Rom. Once it's installed, you can read the "documentation" to get assistance related to Serial IP Redirector. The documentation will be installed to your PC with the software.

The serial IP icon can be found at the right corner of system tray. Right click the icon and select **Configure**, the following window will appear.

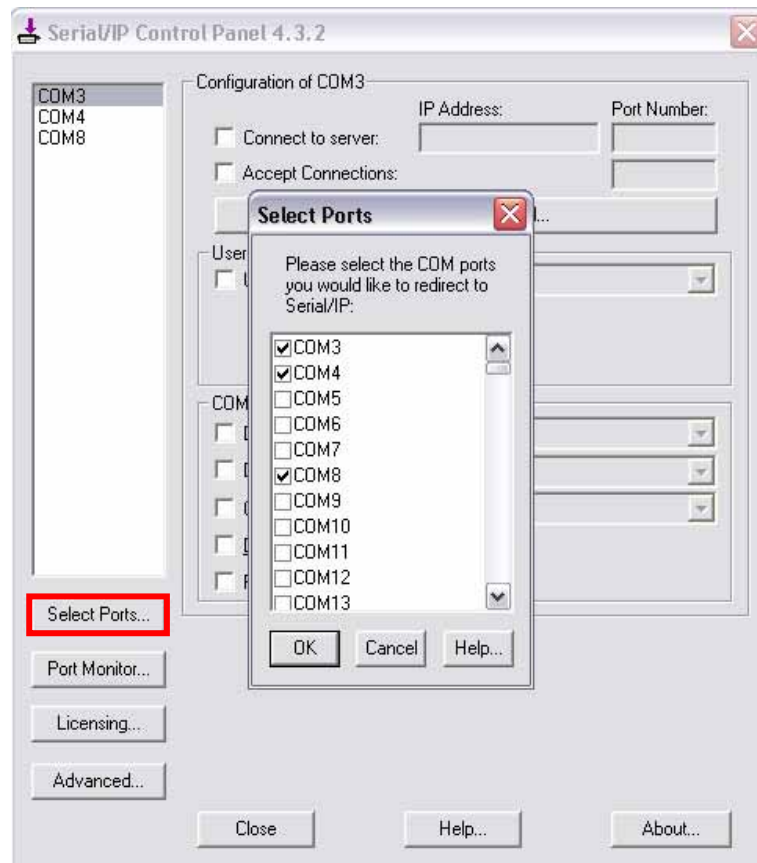

**Note:** Serial IP Redirector software will only work while using the unit as a Device Server. Do not install or use the software while using the unit as Managed Media Converter.

Click on **Select Ports** option to configure the Virtual COM ports. You can select up to 256 virtual COM ports. COM1 and COM2 are normally physical ports, so will not appear here. The selected ports will be shown on the left top corner of the Configure screen.

Selecting the “Connect to server” will allow you to enter IP address and port number. Enter the correct IP address and port number assigned to the Device Server.

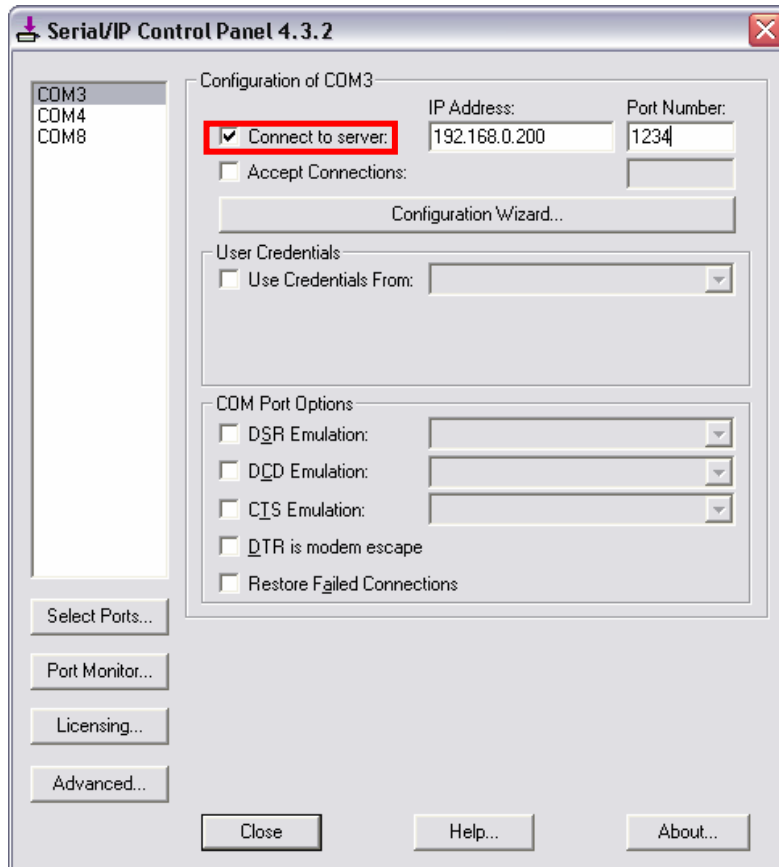



After assigning the IP address and port number, press **Configuration Wizard** button to check if the link is established.

On the following screen, press **Start** button. If the link is function well, the following screen will appear.

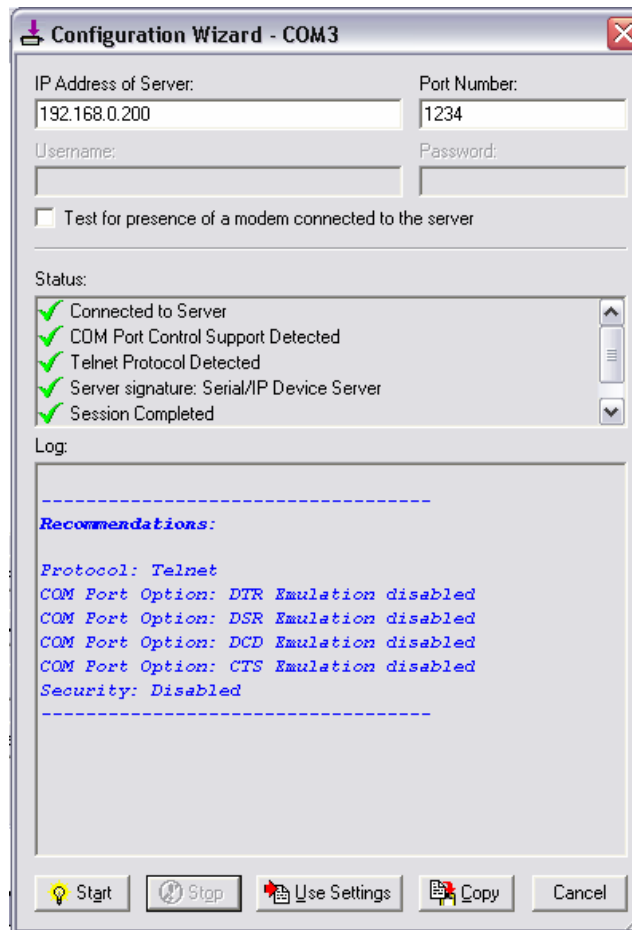

If the link has trouble, the error message will appear. To solve the problem, please check the following:

- a) Whether IP address and Port numbers are correct.
- b) Fiber cable is properly connected to Ethernet.
- c) DIP Switch 7 is correctly selected (4Wire and 2Wire Mode).

Once the link is established, you can manage the serial device attached to the device server from remote workstation installed Serial IP Redirector software.

From the Serial IP **“Port Monitor”** option, you can see the connectivity status and IP address of the device server.

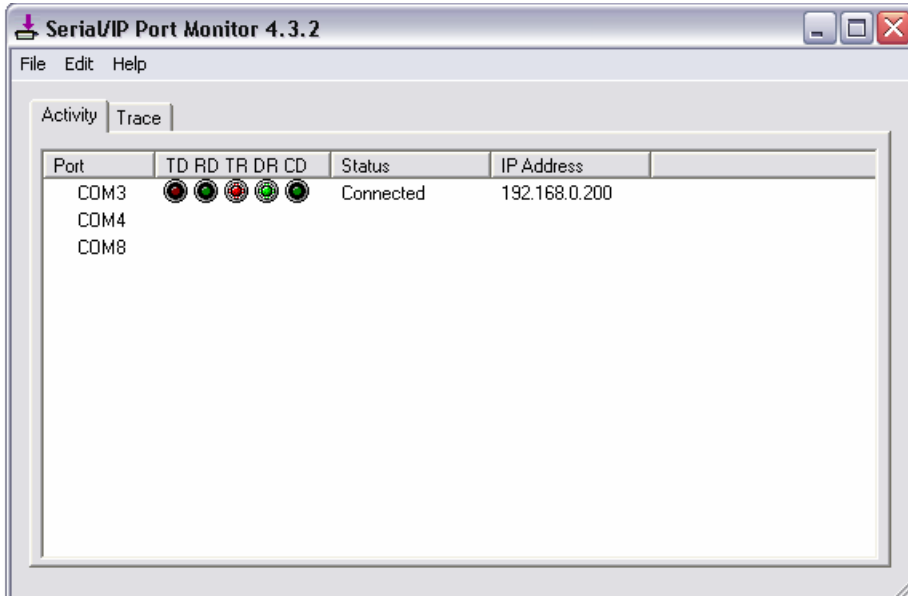

If more devices are attached and connected, the status and IP address of those devices will also be showed against each Virtual COM port as shown below.

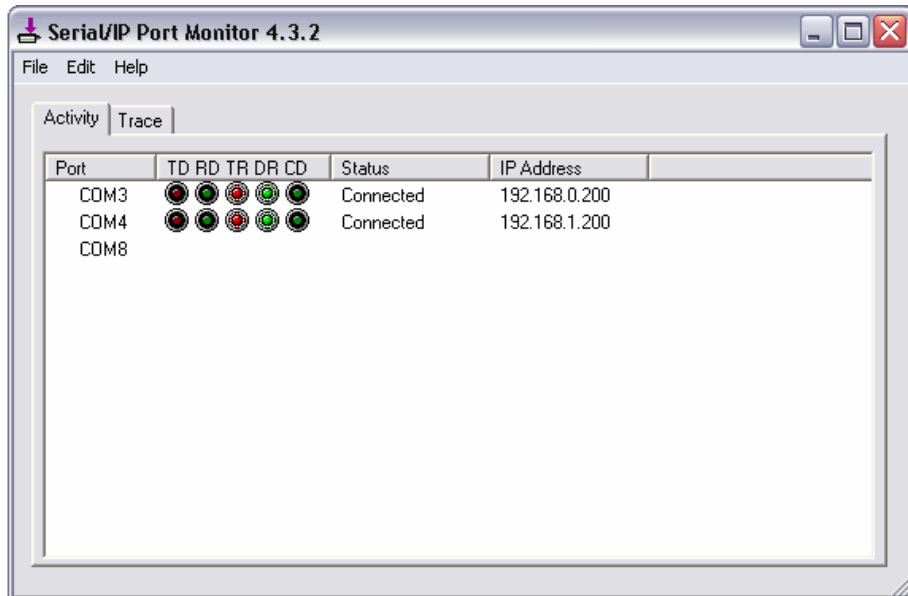

## **8 Contact Information**

VOLKTEK CORPORATION

4F, No. 192 Lian-Cheng Road  
Chung-Ho, Taipei 235, Taiwan ROC

TEL: +886 (2) 8242-1000

FAX: +886 (2) 8242-3333

ISO 9001 Certified